

GENERAL

The AUTOPULSE IQ-636X-2 Agent Releasing Control Panel is designed with modularity and easy system planning. The AUTOPULSE IQ-636X-2 can be configured with just a few devices for small building applications or for a large campus or high-rise application. Simply add additional peripheral equipment to suit the application.

Note: Unless called out with a version-specific "E" at the end of the part number, "IQ-636X-2" refers to models IQ-636X-2 and IQ-636X-2E; similarly, "CPU-636" refers to models CPU-636 and CPU-636E.

FEATURES

- Certified for seismic applications when used with the appropriate seismic mounting kit.
- Approved for Marine applications when used with listed compatible equipment.
- One, expandable to two, isolated intelligent Signaling Line Circuit (SLC) Style 4, 6 or 7.
- Up to 159 detectors (any mix of ion, photo, thermal, or multi-sensor) and 159 modules (NO manual stations, two-wire smoke, notification, or relay) per SLC. 318 devices per loop/636 total.
- A 2x40 character display or optional 16x40 character display.
- Four Notification Appliance Circuits (NAC) providing 1.5 Amps each with built-in Class A/B wiring options. Selectable System Sensor, Wheelock, or Gentex strobe synchronization.
- Built-in Alarm, Trouble, and Supervisory relays.
- VeriFire® Tools online or offline programming utility. Upload/Download, save, store, check, compare, and simulate panel databases. Upgrade panel firmware.
- Autoprogramming and Walk Test reports.
- Optional universal 636-point DACT.
- Up to 32 remote annunciators can be added on EIA-485 bus.
- EIA-485 annunciators, including custom graphics.
- EIA-232 port for printing or PC connection.
- History file with 800-event capacity in nonvolatile memory, plus separate 200-event alarm-only file.
- Alarm Verification selection per point, with tally.
- Positive Alarm Sequence (PAS) presignal.
- Silence inhibit and Auto Silence timer options.
- March time/temporal/California two-stage coding/strobe synchronization.
- Field-programmable on panel or on PC, with VeriFire Tools program check, compare, simulate.
- Full QWERTY keypad.
- Charger for up to 18-200 amp hours of standby power.
- Non-alarm points for lower priority functions.
- Remote ACK/Signal Silence/System Reset/Drill via monitor modules.
- Automatic time control functions, with holiday exceptions.
- Extensive, built-in transient protection.
- Powerful Boolean logic equations.
- USB port for PC connection.



007694

■ AUTOPULSE-NCA-2-character display features:

- Backlit, 640-character display.
- Supports SCS Series smoke control system in both HVAC or FSCS modes (not UL Listed for FSCS).
- Printer and CRT EIA-232 ports.
- EIA-485 annunciator and terminal mode ports.
- Alarm, Trouble, Supervisory, and Security relays.

■ FlashScan® intelligent features:

- Poll 318 devices in less than two seconds.
- Activate up to 159 outputs in less than five seconds.
- Multicolor LEDs blink device address during Walk Test.
- Fully digital, high-precision protocol.
- Manual sensitivity adjustment — nine levels.
- Pre-alarm AWACS™ (Advanced Warning Addressable Combustion Sensing) — nine levels.
- Day/Night automatic sensitivity adjustment.
- Sensitivity windows:
 - Ion** – 0.5 to 2.5%/foot obscuration.
 - Photo** – 0.5 to 2.35%/foot obscuration.
 - Laser (VIEW®)** – 0.02 to 2.0%/foot obscuration.
 - Acclimate™** – 0.5 to 4.0%/foot obscuration.
- Drift compensation.
- Degraded mode — in the unlikely event that the CPU microprocessor fails, FlashScan detectors revert to degraded operation and can activate the CPU NAC circuits and alarm relay. Each of the four built-in panel circuits includes a Disable/Enable switch for this feature.
- Multi-detector algorithm involves nearby detectors in alarm decision.
- Automatic detector sensitivity testing.
- Maintenance alert (two levels).
- Self-optimizing pre-alarm.

■ VIEW Very Intelligent Early Warning smoke detection technology:

- Revolutionary spot laser design.
- Advanced AWACS algorithms differentiate between smoke and non-smoke signals.
- Addressable operation pinpoints the fire location.
- No moving parts to fail or filters to change.
- Early warning performance comparable to the best aspiration systems at a fraction of the lifetime cost.

■ Acclimate low-profile intelligent multi-sensor:

- Detector automatically adjusts sensitivity levels without operator intervention or programming. Sensitivity increases with heat.
- Microprocessor-based technology; combination photo and thermal technology.
- FlashScan or classic mode compatible.
- Low-temperature warning signal at 40 °F ± 5 °F (4 °C ± 3 °C).

FEATURES (Continued)

■ Releasing features:

- Ten independent hazards
- Sophisticated cross-zone (three options)
- Delay timer and Discharge timers (adjustable)
- Abort (four options)
- Low Pressure CO₂ Listed

■ High-efficiency offline switching 3.0 amp power supply (6.0 A in alarm):

- 120 VAC (IQ-636X-2) or 240 VAC (IQ-636X-2E)
- Displays battery current/voltage on panel (with display)

FLASHSCAN EXCLUSIVE NEW WORLD-LEADING DETECTOR PROTOCOL

At the heart of the AUTOPULSE IQ-636X-2 is a set of detection devices and device protocol — FlashScan. FlashScan is an all-digital protocol that gives superior precision and high noise immunity.

In addition to providing quick identification of an active input device, this new protocol can also activate many output devices in a fraction of the time required by competitive protocols. This high speed also allows the AUTOPULSE IQ-636X-2 to have the largest device per loop capacity in the industry — 318 points — yet every input and output device is sampled in less than two seconds. The microprocessor-based FlashScan detectors have bicolor LEDs that can be coded to provide diagnostic information, such as device address during Walk Test.

AWACS ADVANCED WARNING ADDRESSABLE COMBUSTION SENSING

AWACS is a set of software algorithms that provide the AUTOPULSE IQ-636X-2 with industry-leading smoke detection capability. These complex algorithms require many calculations on each reading of each detector, and are made possible by the very-high-speed microcomputer used by the AUTOPULSE IQ-636X-2.

Drift Compensation and Smoothing. Drift compensation allows the detector to retain its original ability to detect actual smoke, and resist false alarms, even as dirt accumulates. It reduces maintenance requirements by allowing the system to automatically perform the periodic sensitivity measurements required by NFPA 72. Smoothing filters are also provided by software to remove transient noise signals, such as those caused by electrical interference.

Maintenance Warnings. When the drift compensation performed for a detector reaches a certain level, the performance of the detector may be compromised, and special warnings are given. There are three warning levels: (1) Low Chamber value, usually indicative of a hardware problem in the detector; (2) Maintenance Alert, indicative of dust accumulation that is near but below the allowed limit; (3) Maintenance Urgent, indicative of dust accumulation above the allowed limit.

Sensitivity Adjust. Nine sensitivity levels are provided for alarm detection. These levels can be set manually, or can change automatically between day and night. Nine levels of pre-alarm sensitivity can also be selected, based on predetermined levels of alarm. Pre-alarm operation can be latching or self-restoring, and can be used to activate special control functions.

Self-Optimizing Pre-Alarm. Each detector may be set for “Self-Optimizing” pre-alarm. In this special mode, the detector “learns” its normal environment, measuring the peak analog readings over a long period of time, and setting the pre-alarm level just above these normal peaks.

Cooperating Multi-Detector Sensing. A patented feature of AWACS is the ability of a smoke sensor to consider readings from nearby sensors in making alarm or pre-alarm decisions. Without statistical sacrifice in the ability to resist false alarms, it allows a sensor to increase its sensitivity to actual smoke by a factor of almost two to one.

FIELD PROGRAMMING OPTIONS

Autoprogram is a timesaving feature of the AUTOPULSE IQ-636X-2. It is a special software routine that allows the AUTOPULSE IQ-636X-2 to “learn” what devices are physically connected and automatically load them in the program with default values for all parameters. Requiring less than one minute to run, this routine allows the user to have almost immediate fire protection in a new installation, even if only a portion of the detectors are installed.

Keypad Program Edit (with KDM-R2). The AUTOPULSE IQ-636X-2 has the exclusive feature of program creation and editing capability from the front panel keypad, **while continuing to provide fire protection.** The architecture of the AUTOPULSE IQ-636X-2 software is such that each point entry carries its own program, including control-by-event links to other points. This allows the program to be entered with independent per-point segments, while the AUTOPULSE IQ-636X-2 simultaneously monitors other (already installed) points for alarm conditions.

VeriFire Tools is an online and offline programming and test utility that can greatly reduce installation programming time, and increase confidence in the site-specific software. It is Windows® based and provides technologically advanced capabilities to aid the installer. The installer may create the entire program for the AUTOPULSE IQ-636X-2 in the comfort of the office, test it, store a backup file, then bring it to the site and download from a laptop into the panel.

ENTER PROG OR STAT PASSWORD, THEN ENTER
(ESCAPE TO ABORT) *****

0=CLR 1=AUTO 2-POINT 3=PASSWD 4=MESSAGE
5=ZONES 6=SPL FUNCT 7=SYSTEM 8=CHECK PRG

Keypad Program Editing

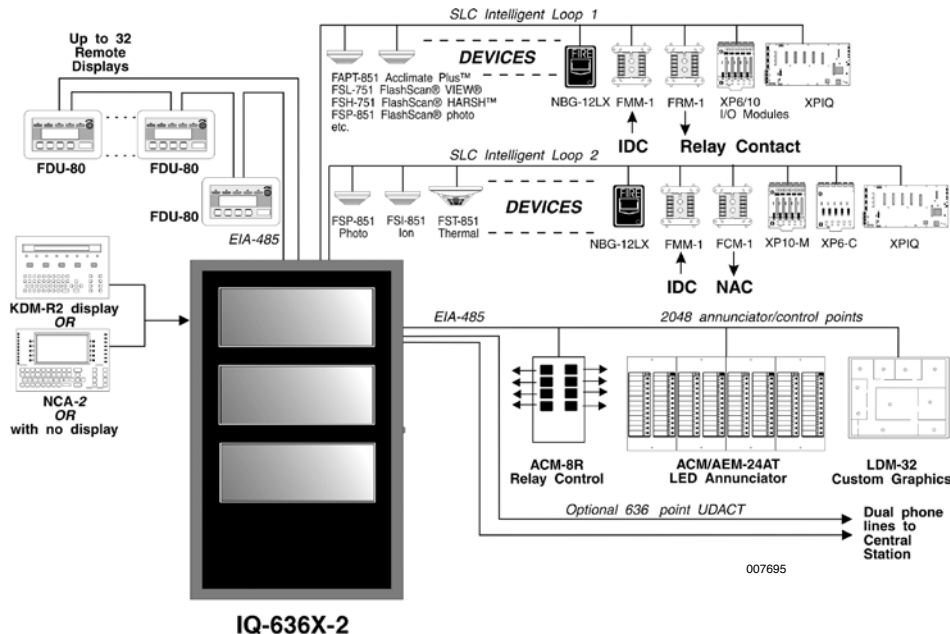

AUTOPROGRAM

PLEASE WAIT

L1: 80 DETS, 15 MODS L2:93 DETS, 35 MODS
BELLS: 04

Autoprogram Function

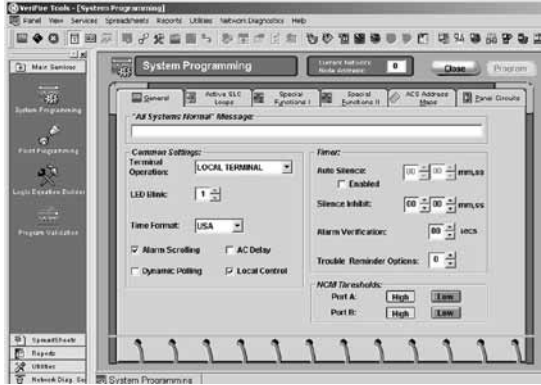

VeriFire Tools System Programming Screen

007187

PLACEMENT OF EQUIPMENT IN CHASSIS AND CABINET

The following guidelines outline the AUTOPULSE IQ-636X-2 flexible system design.

Rows: The first row of equipment in the cabinet mounts in chassis CHS2-M2. Mount the second, third, or fourth rows of equipment in chassis CHS2-4MB (see AUTOPULSE IQ-636X-2 Installation Manual regarding panel output modules) or CHS2-4L.

Wiring: When designing the cabinet layout, consider separation of power-limited and non-power-limited wiring as discussed in the IQ-636X Installation Manual.

Positions: A chassis offers four basic side-by-side positions for components; the number of modules that can be mounted in each position depends on the chassis model and the size of the individual module. There are a variety of standoffs and hardware items available for different combinations and configurations of components.

It is critical that all mounting holes of the AUTOPULSE IQ-636X-2 are secured with a screw or standoff to ensure continuity of earth ground.

CPU-636 Board Diagram

TB10: DC Power (24 VDC, power-limited); Non-Resettable, Resettable.

TB11: EIA-485 Connection (supervised); Terminal Mode, ACS Mode.

TB12: EIA-232 Connection; Printer, PC/Terminal (CRT).

J1: Network/Service Connection (NUP), power-limited, supervised.

J2: USB A VeriFire Tools Connection.

J3: USB B VeriFire Tools Connection.

TB13: SLC Loop #1 (supervised, power-limited).

JP1: Ground Fault Jumper (SLC #1).

JP2: Cut for 200 mA operation.

All NAC circuits are power-limited, supervised.

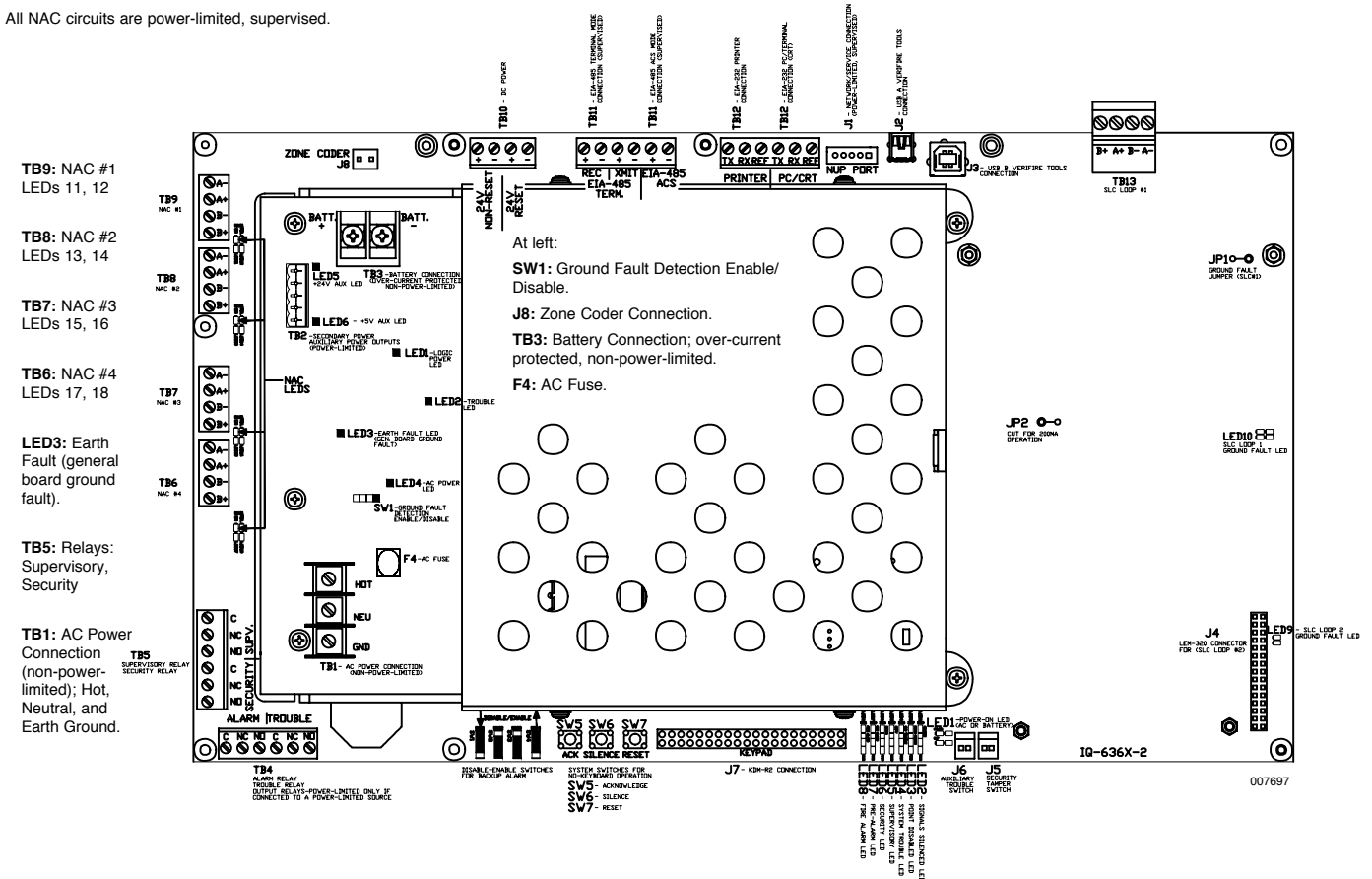

007697

TB4: Alarm Relay, Trouble Relay. Output relays; power-limited only if connected to a power-limited source.

SW1, SW2, SW3, SW4: Disable-Enable switches for Backup Alarm, NACs 1-4 respectively.

System switches, "No Keyboard Operation":
SW5: Acknowledge
SW6: Silence
SW7: Reset
J7: KDM-R2 Connection

LED1: Power On (AC or battery)
LED2: Signals Silenced
LED3: Point Disabled
LED4: System Trouble
LED5: Supervisory

LED6: Security
LED7: Pre-Alarm
LED8: Fire Alarm
LED10: SLC Loop #1 Ground Fault
J6: Auxiliary Trouble Input

LED9: SLC Loop #2 Ground Fault
J4: LEM-320 Connector for SLC Loop #2
J5: Security Tamper Switch
J6: Auxiliary Trouble Input

Equipment Placement in CHS2-M2 Chassis

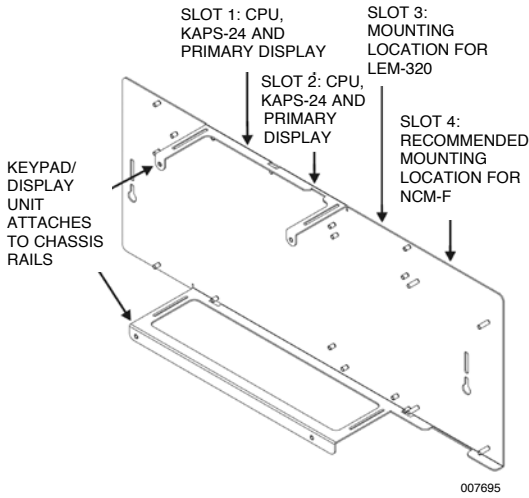

Layers: The CHS-2-M2 accepts four layers of equipment, including the control panel. The CPU fills three positions (left to right) in the first-installed layer (the back of the chassis); its integral power supply occupies (the left) two positions in the next two layers; the optional display occupies (the left) two positions at the front, flush with the door. Some equipment, such as the AUTOPULSE-NCA-2, may be door-mounted directly in front of the control panel. The AUTOPULSE-NCA-2 mounts onto the DP-DISP. The AUTOPULSE-NCA-2 can be used as a primary display for the AUTOPULSE IQ-636X-2 by directly connecting their network ports (required in Canadian stand-alone applications).

Expansion: Installing an LEM-320 Loop Expander Module adds a second SLC loop to the control panel. The LEM-320 is mounted onto the CPU, occupying the middle-right, second (back) slot on the chassis. Option boards can be mounted in front of the LEM-320 for ease of access, complete installation of those devices before mounting another layer.

KDM-R2 CONTROLS AND INDICATORS

Program Keypad: QWERTY type (keyboard layout).

12 LED indicators: Power; Fire Alarm; Pre-Alarm; Security; Supervisory; System Trouble; Signals Silenced; Points Disabled; Control Active; Abort; Pre-Discharge.

Membrane Switch Controls: Acknowledge/Scroll Display; Signal Silence; Drill; System Reset; Lamp Test.

LCD Display: 80 characters (2 x 40) with long-life LED backlight.

CONFIGURATION GUIDELINES

Display options are the KDM-R2 or the AUTOPULSE-NCA-2. Other options listed as follows:

KDM-R2: 80-character backlit LCD display with QWERTY programming and control keypad. Order two BMP-1 blank modules and DP-DISP2 mounting plate separately. Requires top row of a cabinet. Required for each stand-alone 80-character display system. The KDM-R2 may mount in network nodes to display "local" node information as long as at least one NCA-2 network display is on the system to display network information.

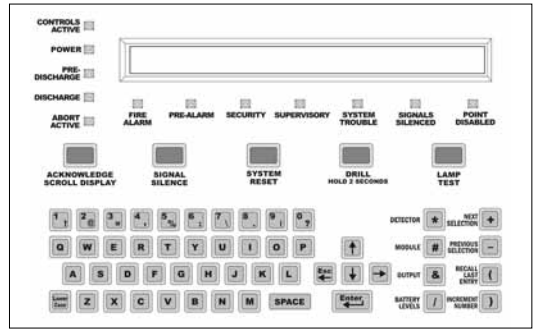

KDM-R2 Display

007698

AUTOPULSE-NCA-2: Network Control Annunciator, 640 characters. The NCA may be used as the primary display instead of the KDM-2. The NCA provides a 640 character display and mounts in the DP-DISP.

CPU-636: Central processing unit with integral 3.0 amp (6.0 A in alarm) power supply for an AUTOPULSE IQ-636X-2 system. Includes CPU; one Signaling Line Circuit expandable to two; installation, programming and operating manuals.

CPU-636: Same as CPU-636 but requires 220 VAC, 1.5 amp, (3.0 A in alarm).

DP-DISP2: Dress panel for top row in cabinet with CPU installed.

BMP-1: Blank module for unused module positions.

ADP2-636: Dress panel for middle rows with CPU-636/ IQ-636X-2(E).

BP2-4: Battery plate, required.

LEM-320: Loop Expander Module. Expands each AUTOPULSE IQ-636X-2 to two Signaling Line Circuits.

SYSTEM MODULES

The AUTOPULSE IQ-636X-2 includes the ability to communicate with up to eight conventional modules each with up to eight circuits. Any mix of notification or relay may be used. Choose any combination of up to eight output modules: ICM/ICE, CRM/CRE, DCM-4 or VCM/VCE. Panel modules mount on either: the two far-right positions of the DP-DISP (next to the primary display); or on any of the four positions on the CHS-4N chassis (CHS-4MN kit required). **Notes:** 1) These modules/expanders are NOT to be used for releasing applications. 2) For additional information on these panel output modules and expanders.

ACPS-610: 6.0 A or 10 A addressable charging power supply.

APS2-6R: Auxiliary Power Supply. Provides up to 6.0 amperes of power for peripheral devices. Includes battery input and transfer relay, and overcurrent protection. Mounts on two of four positions on a CHS-4L or CHS-4 chassis.

CHS-4MB: Expansion Chassis. Mounts up to four modules. Includes CHS-4N, MP-1B (Module Dress Panel), and Expander Ribbon Cable.

OTHER OPTION MODULES

PRN-6: 80-column printer.

ACM-24AT: ACS annunciator – up to 96 points of annunciation with Alarm or Active LED, Trouble LED, and switch per circuit. Active/Alarm LEDs can be programmed (by powered-up switch selection) by point to be red, green, or yellow; the Trouble LED is always yellow.

AEM-24AT: Same LED and switch capabilities as ACM-24AT, expands the ACM-24AT to 48, 72, or 96 points.

OTHER OPTION MODULES (Continued)

ACM-48A: ACS annunciator – up to 96 points of annunciation with Alarm or Active LED per circuit. Active/Alarm LEDs can be programmed (by powered-up switch selection) in groups of 24 to be red, green, or yellow. Expandable to 96 points with one AEM-48A.

AEM-48A: Same LED capabilities as ACM-48A, expands the ACM-48A to 96 points.

FCPS-24S6/-24S8: Remote six amp and eight-amp power supplies with battery charger.

ACS: Annunciator Control Modules ACM-24AT, AEM24AT, ACM-28A, and AEM-28A.

FDU-80: 80 character, backlit LCD display. Mounts up to 6,000 ft (1828.8 m) from panel. Up to 32 per AUTOPULSE IQ-636X-2.

LCD2-80: Terminal mode. 80-character, backlit LCD display. Mounts up to 6000 ft (1828.8 m) from panel. Up to 32 per AUTOPULSE IQ-636X-2.

AFM: Annunciator Fixed Modules AFM-16A, AFM16AT, and AFM-32A.

LDM: Lamp Driver Modules LDM-32, LDM-E32, and LDM-R32.

TM-4: Transmitter module. Includes three reverse-polarity circuits and one municipal box circuit. Mounts in panel module position (single-address-style).

ACM-8R: Remote Relay Module with eight Form-C contacts. Can be located up to 6,000 ft (1828.8 m) from panel on four wires.

CHS-4: (at right) Chassis for mounting up to four APS-6Rs.

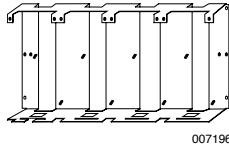

CHS-4L: (at right) Low-profile four-position Chassis. Mounts two AA30 amplifiers or one AMGE and one AA30.

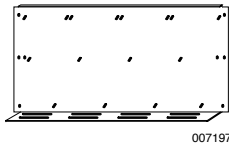

DP-1B: (at right) Blank Dress panel. Provides dead-front panel for unused tiers or to cover AA30, AA-120, or AMGE.



CAB-4 Series: The CAB-4 Series cabinets are fabricated from 16-gauge steel with unique full-front LEXAN®, reverse-silk-screened for durability.

The cabinet assembly consists of two basic parts: a Backbox (SBB-4), and a Locking Door (DR-4) that may hinge right or left. Cabinets are available in four sizes, "A" through "D," with one to four tiers (two-tiered "B" shown at right). A trim ring option is available for semi-flush mounting.

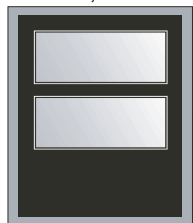

MARINE-EQ System: Protects equipment in shipboard and waterfront applications.

NFS-LBBR: Battery Box. Required for batteries larger than 26 AH. Red.

SEISKIT-CAB: Seismic mounting kit. Required for seismic-certified applications with the AUTOPULSE IQ-636X-2 and BB-26. Includes battery bracket for two 26 AH batteries.

SEISKIT-LBB: Seismic kit for the NFS-LBB. Includes battery bracket for two 55 AH batteries.

SEISKIT-PS/2/4: Seismic mounting kit for the FCPS-24S6/S8 and CAB-PS1. Includes battery bracket for two 7 AH or 12 AH batteries.

COMPATIBLE DEVICES, EIA-485 PORTS

ACS Series: Remote serial annunciator/control systems.

FDU-80: Remote LCD display, 80 characters, with LEDs.

LCD-80: Remote LCD display, 80 characters.

LDM Series: Remote custom graphic driver modules.

ACM-8R: Remote relay module. 8 Form-C relays.

UDACT: Universal Digital Alarm Communicator Transmitter, 636 channel.

UDACT-2: Universal Digital Alarm Communicator Transmitter, 636 channel.

COMPATIBLE INTELLIGENT DEVICES

FSI-851: Low-profile FlashScan ionization detector.

FSP-851: Low-profile FlashScan photoelectric detector.

FSP-851T: Low-profile FlashScan photoelectric detector with 135 °F (57 °C) thermal.

FSP-851R: FSP-851, remote-test capable. For use with DNR (W).

FST-851: FlashScan thermal detector 135 °F (57 °C).

FST-851R: FlashScan thermal detector 135 °F (57 °C) with rate-of-rise.

FST-851H: FlashScan 190 °F (88 °C) high-temperature thermal detector.

FAPT-851: FlashScan Acclimate Plus low-profile multi-sensor detector.

FSL-751: FlashScan VIEW laser photo detector.

DNR: InnovairFlex low-flow non-relay duct-detector housing (order FSP-851R separately). Replaces FSD-751PL/ FSD-751RPL.

DNRW: Same as above with NEMA-4 rating, watertight.

B224RB: Low-profile relay base.

B224BI: Isolator base for low-profile detectors.

B210LP: Low-profile base. Standard U.S. style. Replaces B710LP.

B501: European-style, 4 in. (102 mm) base.

B200S: Intelligent programmable sounder base, capable of producing a variety of tone patterns including ANSI Temporal 3. Compatible with synchronization protocol.

B200SR: Sounder base, Temporal 3 or Continuous tone.

FMM-1: FlashScan monitor module.

FDM-1: FlashScan dual monitor module.

FZM-1: FlashScan two-wire detector monitor module.

FMM-101: FlashScan miniature monitor module.

FCM-1: FlashScan NAC control module.

FCM-1-REL: FlashScan releasing control module.

FRM-1: FlashScan relay module.

FDRM-1: FlashScan dual monitor/dual relay module.

NBG-12LX: Manual fire alarm station, addressable.

ISO-X: Isolator module.

XP6-C: FlashScan six-circuit supervised control module.

XP6-MA: FlashScan six-zone interface module; connects intelligent alarm system to two-wire conventional detection zone.

XP6-R: FlashScan six-relay (Form-C) control module.

XP10-M: FlashScan ten-input monitor module.

OTHER OPTIONS

TM-4: Transmitter Module. Includes three reverse-polarity circuits and one municipal box circuit. Mounts in panel module position (single-address-style) or in CHS-M2 position.

AUTOPULSE-TCD: AUTOPULSE Tools CD-ROM. Contains programming software for the AUTOPULSE IQ-636X-2, AUTOPULSE-NCA, IQ-636, IQ-318, NCA-2, and XPIQ. Includes local panel connection cable. Programming PC requires a serial port connection.

BAT Series: Batteries. AUTOPULSE IQ-636X-2 utilizes two 12 volt, 18 to 60 AH batteries.

Note: For other options including compatibility with retrofit equipment, refer to the panel's installation manual, the SLC manual, and the Device Compatibility Document.

SYSTEM SPECIFICATIONS

System Capacity

Intelligent Signaling Line Circuits 1 expandable to 2
Intelligent detectors 159 per loop
Addressable monitor/control modules 159 per loop
Programmable software zones 99
Special programming zones 14
LCD annunciators per CPU-636/636E and NCA-2 (observe power) . . 32
ACS annunciators per CPU-636/636E 32 addresses x 64 points
ACS annunciators per NCA-2 32 addresses x 64 or 96 points

Note: The NCA-2 supports up to 96 annunciator address points per ACM-24/48.

Specifications

- Primary input power, **CPU-636 board:** 120 VAC, 50/60 Hz, 5.0 A.
CPU-636E board: 220/240 VAC, 50/60 Hz, 2.5A.
- Total output 24 V power: 6.0 A in alarm.

Note: The power supply has a total of 6.0 Amps of available power. This is shared by all internal circuits.

- Standard notification circuits (4): 1.5 A each.
- Four-wire detector power (Resettable regulated 24V power outputs): 1.25 A.
- Two non-resettable regulated 24V power outputs:
 - 1.25 A.
 - 0.50 A.
- Non-resettable 5V power.
- Battery charger range: 18 AH – 200 AH. Use separate cabinet for batteries over 26 AH.
- Float rate: 27.6 V.

Temperature and Humidity Ranges

This system meets NFPA requirements for operation at 32 °F – 120 °F (0 °C – 49 °C) and at a relative humidity 93% ± 2% RH (noncondensing) at 90 °F ± 3 °F (32 °C ± 2 °C). However, the useful life of the system's standby batteries and the electronic components may be adversely affected by extreme temperature ranges and humidity. Therefore, it is recommended that this system and its peripherals be installed in an environment with a normal room temperature of 60 °F – 80 °F (15 °C – 27 °C).

STANDARDS

The AUTOPULSE IQ-636X-2 complies with the following UL Standards and NFPA 72 Fire Alarm System requirements:

- UL 864, 9th Edition (Fire)
- UL 1076 (Burglary)
- LOCAL (Automatic, Manual, Waterflow and Sprinkler Supervisory)
- AUXILIARY (Automatic, Manual and Waterflow) (requires 4XTMF)
- REMOTE STATION (Automatic, Manual and Waterflow) (requires 4XTMF)
- PROPRIETARY (Automatic, Manual and Waterflow) (not applicable for FM)

AGENCY LISTINGS AND APPROVALS

These listings and approvals apply to the basic AUTOPULSE IQ-636X-2 control panel. In some cases, certain modules may not be listed by certain approval agencies, or listing may be in process. Consult factory for latest listing status.

The AUTOPULSE IQ-636X-2 complies with UL Standards 864, 9th Edition (Fire). It is designed to meet NFPA 72 Local, Auxiliary, Remote Station, and Proprietary (not applicable for FM) Fire System Requirements.

UL Listed S4935
ULC Listed S4935
FM Approved
MEA 128-07-E
California State Fire Marshall 7165-0595:117
FDNY COA#6043
OSHPD OSP-0072-10
City of Chicago
City and County of Denver
CCCF Listed

When used with the MARINE-EQ, appropriate seismic bracket, and marine approved devices, these agent releasing control panels are approved by the following agencies:

US Coast Guard 161.002/A50/0 (Standard 46 CFR)

ORDERING INFORMATION

Part No.	Description
434961	AUTOPULSE IQ-636X-2 Kit Containing: (1) 434953 AUTOPULSE IQ-636X-2 CPU (1) 433614 Black Display Dress Panel-2 CP-DISP2 (1) 433613 KDM-R2 (2) 432794 Black Module Dress Plate BMP-1 (1) 433526 CAB A4R Red (1) 433522 CAB A4R Door, Lock and Keys – Red (1) 434955 Battery Dress Plate BP2-4
434954	AUTOPULSE IQ-636X-2E, 220/240 VAC (CPU only)

AUTOPULSE and the product names listed in this material are marks and/or registered marks. Unauthorized use is strictly prohibited.